

# ACUMIOS

## ECLAT Round Kitchen Mixer Tap Installation Instructions



[www.acumios.com.au](http://www.acumios.com.au)

# Installation Manual

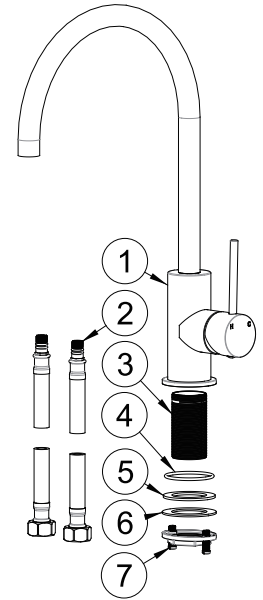
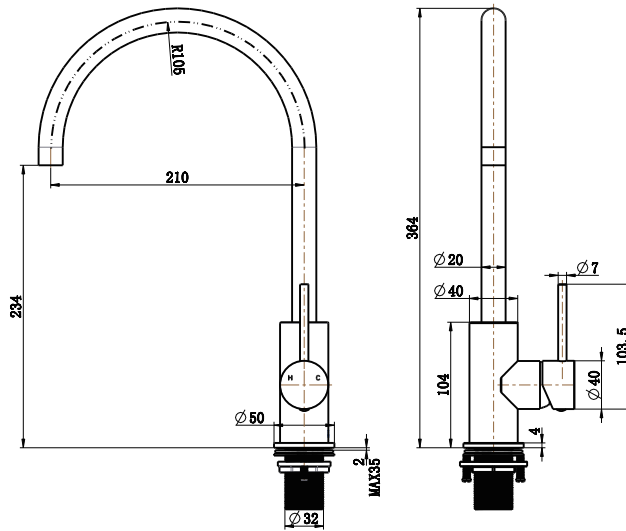

## NO.Ddescription

- 1.Main body
- 2.Inlet hose
- 3.Sleeve
- 4.O-ring
- 5.Washer
- 6.Gasket
- 7.Locking nut

## QTY

- X1  
X1  
X1  
X1  
X1  
X1  
X1  
X1

## General information

- 1.Prior to installing a tap, all pipes leading to the product must be flushed clean.
- 2.Products are manufactured as per standard AS/NZS 3718:2021 and with WaterMark & WELS certificate as shown in the packing.
- 3.All surfaces should be cleaned with water or mild liquid detergent. Do not use cream cleaner or citrus based or chemical cleaning products.



recommended working pressure

0.05-1 MPa



maximum hot water temperature

55 degrees

# Installation Instruction

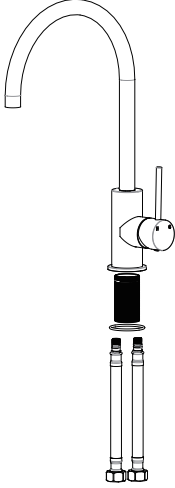
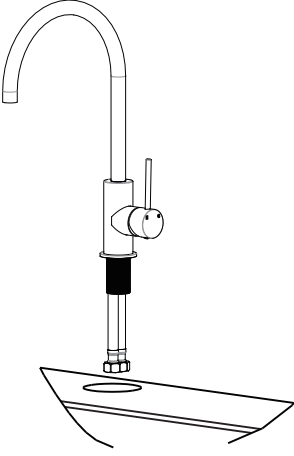
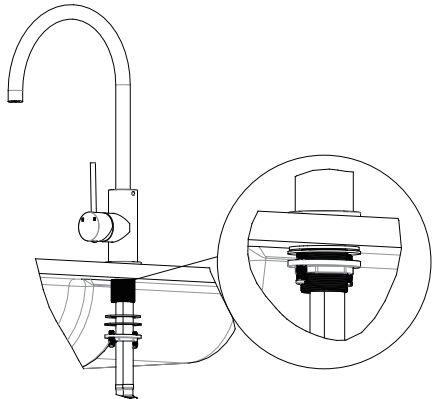
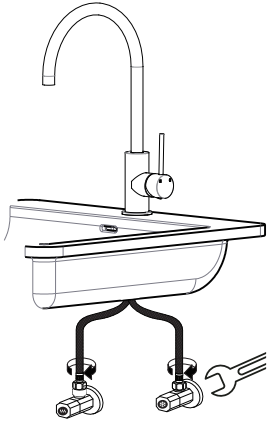
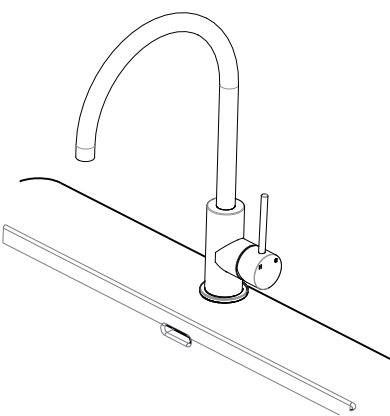
<p>Step 1</p>  <p>Mount ③ ④ ② through ①</p>	<p>Step 2</p>  <p>Insert ① into the hole</p>	<p>Step 3</p>  <p>Install and fix ⑤ ⑥ ⑦</p>
<p>Step 4</p>  <p>Connect ② to the water supply.</p>	<p>Step 5</p>  <p>Test water</p>	

## The warranty will be void for any of the following reasons

- The product has been damaged through misuse, neglect or accident.
- The product has not been used in accordance with any applicable instruction guide.
- The purchaser has attempted to modify or repair the product.
- The product is not installed by a Registered Plumber.

## ▪ Contact Information:

Email: [support@acumios.com.au](mailto:support@acumios.com.au)

Website: [www.acumios.com.au](http://www.acumios.com.au)



  
ACUMIOS